

DIRECT DRIVE 3-WAY VACUUM SOLENOID VALVES WITH LOW ABSORPTION ELECTRIC COIL

The direct drive 3-way vacuum solenoid valves of this series feature two positions with conical shutters servo-controlled by the vacuum.

As a standard they are normally supplied closed, but upon request they can also be provided as normally open.

They are composed of an anodised aluminium body where the connections are located, two silicon shutters assembled onto a stainless steel stem and a membrane in special reinforced compound. A solenoid pilot valve activated by a built-in electric coil manages the servo-control vacuum. The operating principle of these solenoid valves is based upon the pressure differential between the vacuum pump or generator and the pressure of the sucked air. By directing this differential pressure to the servo-control via the solenoid pilot valve, it is possible to control the shutters with no need for compressed air or springs.

Due to their operating principle, these solenoid valves are not recommended for low vacuum level plants (below 850 mbar abs., equal to 15 % of vacuum).

The absence of springs, frictions and internal dynamic stresses favours a high response speed and guarantees a long lasting operation.

The electric coil of the solenoid pilot valve is fully plasticised with synthetic resin, tight execution, insulation class F (up to 155 °C) compliant with VDE standards, with 3 mm 2-terminal electrical connections in compliance with EN 175301-803 (ex DIN 43650) -C. Protection degree IP 54; IP 65 for inserted connector.

Available for voltages of 12-24V/50-60Hz and 12-24V/CC.

Allowed tolerance on the voltage nominal value: ±10%.

Maximum electric power: 2 W

The connector can be rotated by 180° on the coil and can be supplied, upon request, with Led lights, anti-interference circuit and/or with protection devices against overvoltage and polarity reversal. A push-button device built-in the solenoid pilot valve allows the manual opening and closing of the solenoid valve.

The solenoid valves of this series can be used in almost all the cases described for the 07 .. 11 series, and also on plants with no compressed air.

The solenoid valve must always be chosen according to the capacity and, therefore, to the vacuum pump or generator suction connection.

Working pressure: from 0.5 to 850 mbar abs.

Temperature of the sucked fluid: from -5 to +60 °C

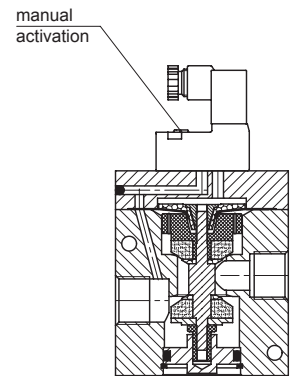
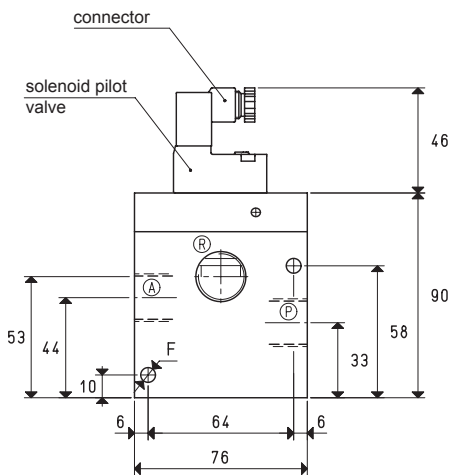

NC

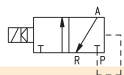

R = Pump
A = Service
P = Passage

N0

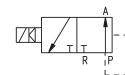

R = Passage
A = Service
P = Pump

| Art. | A | Max. capacity cum/h | Vacuum level mbar abs. | | Reaction time msec | | Ø orifice | passage section mm ² | F | Weight Kg |
|-------------|-------|------------------------|---------------------------|-----|-----------------------|--------|--------------|---------------------------------------|-----|--------------|
| | | | min | max | exc. | deexc. | | | | |
| 07 03 43 NC | G1/2" | 20 | 850 | 0.5 | 33 | 17 | 15 | 176 | 6.5 | 1.35 |
| 07 03 43 N0 | | | | | 22 | 20 | | | | |
| 07 04 43 NC | G3/4" | 40 | 850 | 0.5 | 33 | 17 | 20 | 314 | 6.5 | 1.30 |
| 07 04 43 N0 | | | | | 22 | 20 | | | | |

Note: Please specify the electric coil voltage in the order (E.g.: 07 03 43 NC V24-CC)

The connector is not integral part of the solenoid valve and, therefore, must be ordered separately (See solenoid valve accessories).

DIRECT DRIVE 3-WAY VACUUM SOLENOID VALVES WITH LOW ABSORPTION ELECTRIC COIL

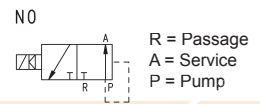
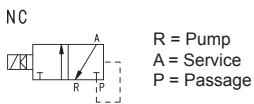
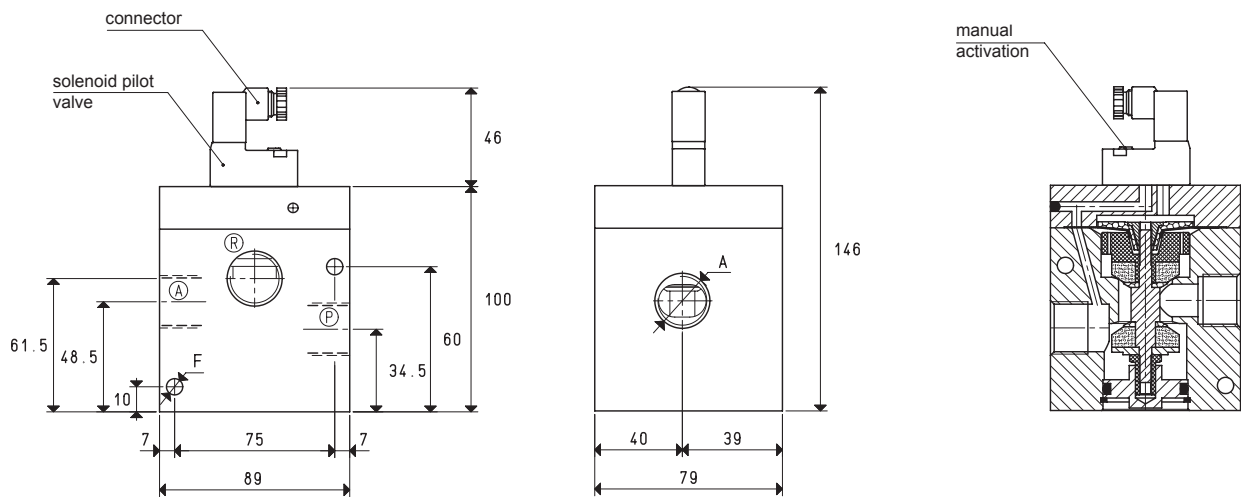

| Art. | A | Max. capacity | Vacuum level | | Reaction time | | Ø | Passage section | F | Weight |
|-------------|-----|---------------|--------------|-----|---------------|--------|----|-----------------|-----|--------|
| | | | min | max | exc. | deexc. | | | | |
| 07 05 43 NC | G1" | 90 | 850 | 0.5 | 42 | 20 | 25 | 490 | 6.5 | 1.65 |
| 07 05 43 NO | | | | | 28 | 22 | | | | |

Note: Please specify the electric coil voltage in the order (E.g.: 07 05 43 NC V24-CC)

The connector is not integral part of the solenoid valve and, therefore, must be ordered separately (See solenoid valve accessories).