

3-WAY VACUUM SOLENOID VALVES WITH BISTABLE IMPULSE SOLENOID PILOT VALVE AND WITH LOW ABSORPTION ELECTRIC COIL

These solenoid valves have the same functions and structure as the previously described ones.

Their distinctive feature is a bistable impulse solenoid valve activated by a built-in low absorption electric coil which, at a simple electric impulse, exchanges the shutter position even in absence of electricity, until it receives a new impulse of opposite polarity. For this reason, they can only be supplied with DC electric coils.

They are particularly recommended in all those cases that require a safe connection to the vacuum source, even in absence of electricity.

The electric coil of the solenoid pilot valve is fully plasticised with synthetic resin, tight execution, insulation class F (up to 155 °C) compliant with VDE standards, with 3 mm 2-terminal electrical connections in compliance with EN 175301-803 (ex DIN 43650)-C. Protection degree IP 54; IP 65 for inserted connector.

Available for voltages of 12-24V/CC.

Allowed tolerance on the voltage nominal value: $\pm 10\%$.

Maximum electric power: 1 W

The connector can be rotated by 180° on the coil and can be supplied, upon request, with Led lights, anti-interference circuit and/or with protection devices against overvoltage and polarity reversal.

The push-button device for their manual activation cannot be installed on these solenoid valves.

Technical features

Working pressure: from 0.5 to 850 mbar abs.

Temperature of the sucked fluid: from -5 to +60 °C

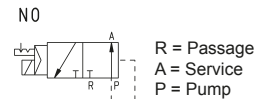
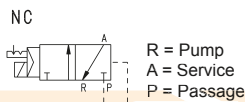
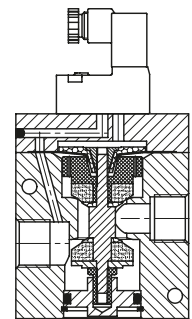
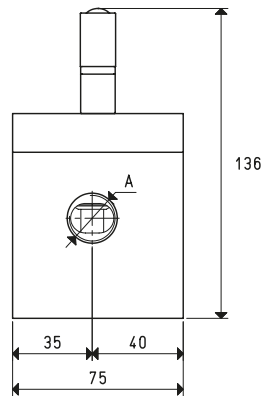
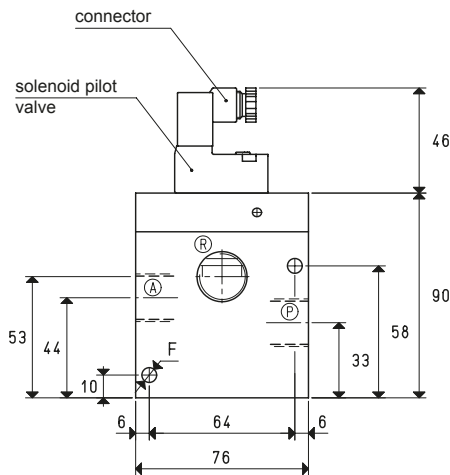

Art.	A	Max. capacity cum/h	Vacuum level mbar abs.		Reaction time msec		Ø orifice	Passage section mm ²	F Ø	Weight Kg
			min	max	exc.	deexc.				
07 03 63 NC	G1/2"	20	850	0.5	33	17	15	176	6.5	1.35
07 03 63 NO					22	20				
07 04 63 NC	G3/4"	40	850	0.5	33	17	20	314	6.5	1.30
07 04 63 NO					22	20				

Note: Please specify the electric coil voltage in the order (E.g.: 07 03 63 NC V24-CC)

The connector is not integral part of the solenoid valve and, therefore, must be ordered separately (See solenoid valve accessories).

3-WAY VACUUM SOLENOID VALVES WITH BISTABLE IMPULSE SOLENOID PILOT VALVE AND WITH LOW ABSORPTION ELECTRIC COIL

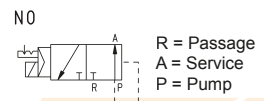
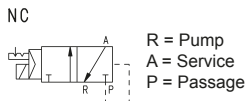
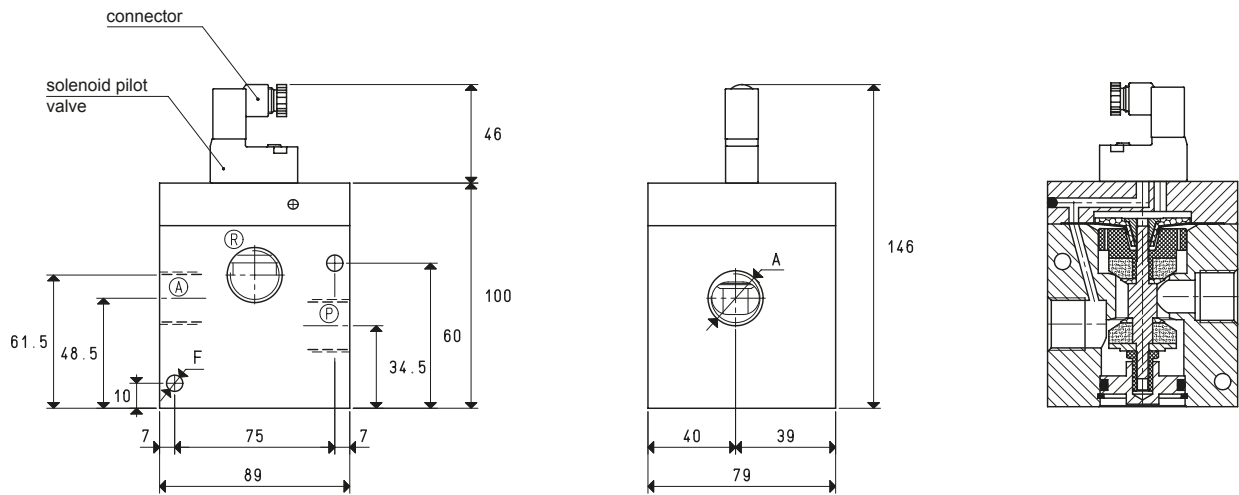

Art.	A	Max. capacity cum/h	Vacuum level mbar abs.		Reaction time msec		Ø orifice	Passage section mm ²	F Ø	Weight Kg
			min	max	exc.	deexc.				
07 05 63 NC	G1"	90	850	0.5	42	20	25	490	6.5	1.05
07 05 63 NO					28	22				

Note: Please specify the electric coil voltage in the order (E.g.: 07 05 63 NC V24-CC)

The connector is not integral part of the solenoid valve and, therefore, must be ordered separately (See solenoid valve accessories).